

Velkomin í íslensku umferðarmerjaskrána

Þessi skrá inniheldur öll önnur merki (K - merki) samkvæmt íslenskri umferðarmerkjareglugerð í mælikvarða 1:4. Hver merki hefur sitt „lag“. Auk merkjanna eru málsetningar í skránni. Athugið að táknin eru öll „læst“. Hægt er að taka af þeim afrit en til að vinna með þau þarf að „opna“ þau.

Gangi ykkur vel!





K01.11 Vegstika,
vinstri



K01.11 Vegstika,
hægri



K01.21 Snjóstika,hægri



K01.21 Snjóstika,vinstri





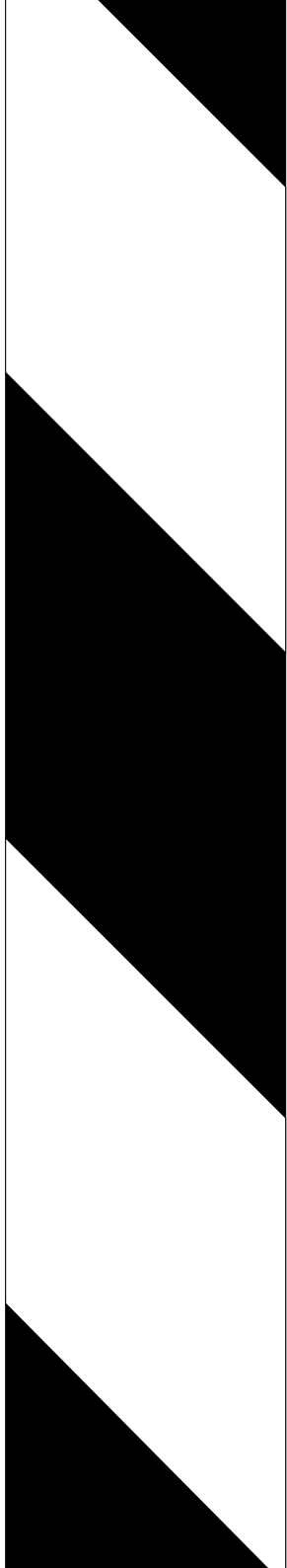

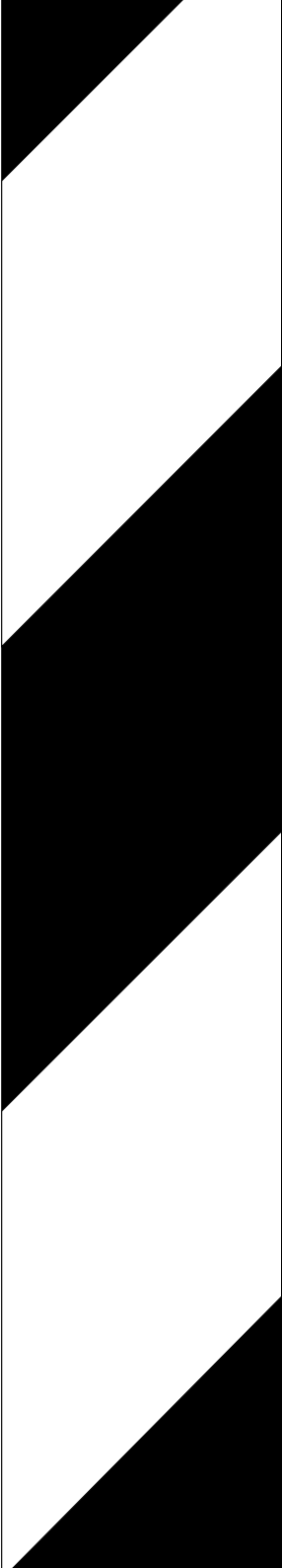

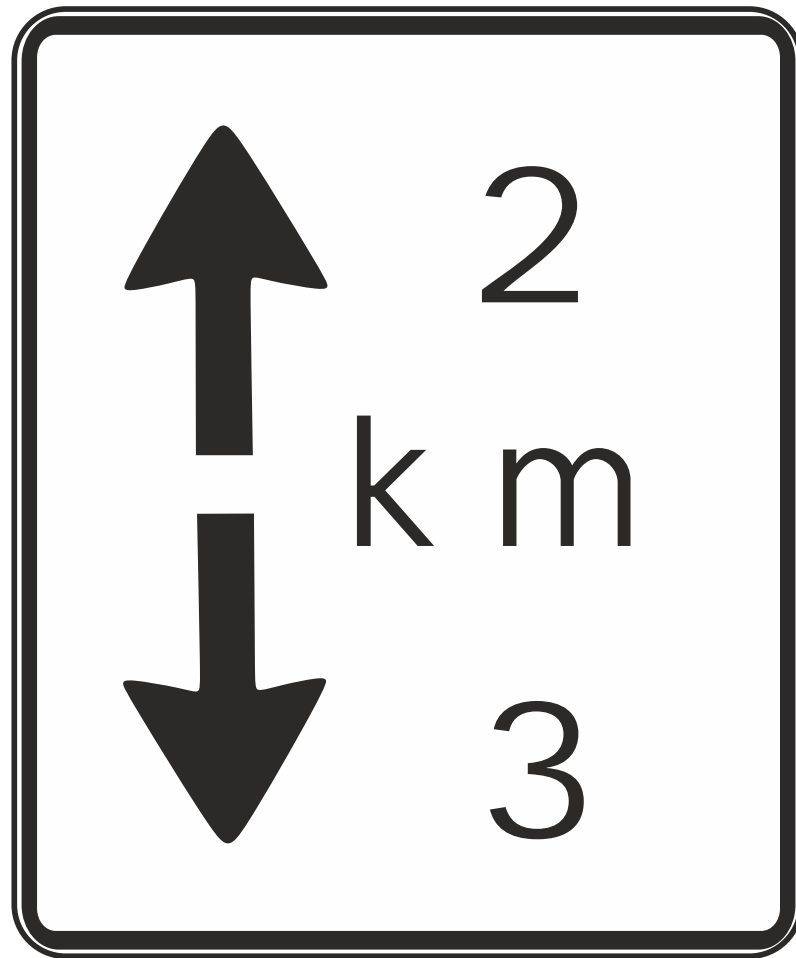

K13.51 Fjarlgöðarmerking í jarðgöngum



K14.11 Gátskjöldur á
brú

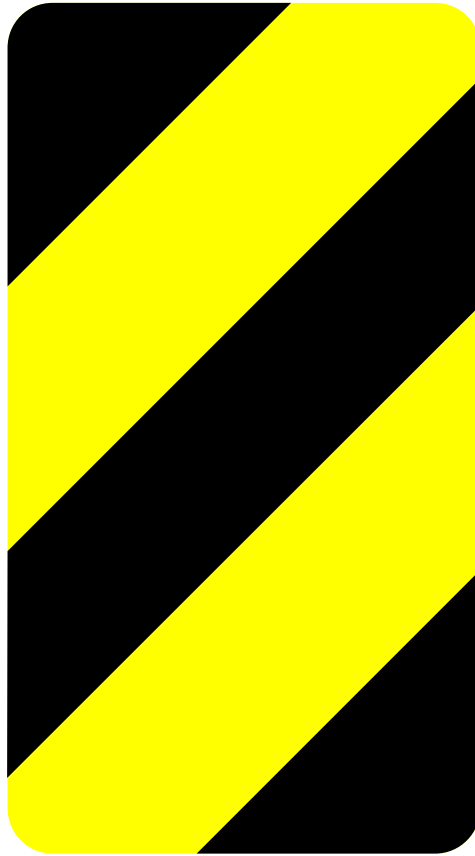

K14.12 Gátskjöldur á
brú

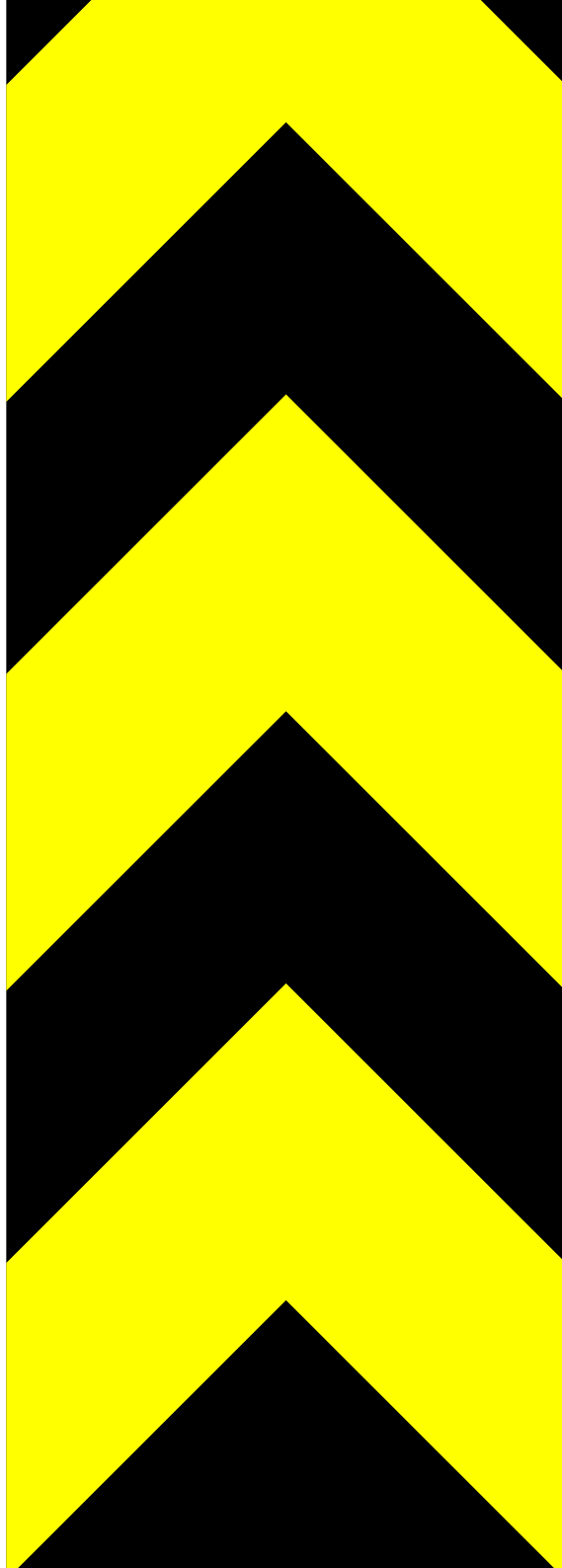

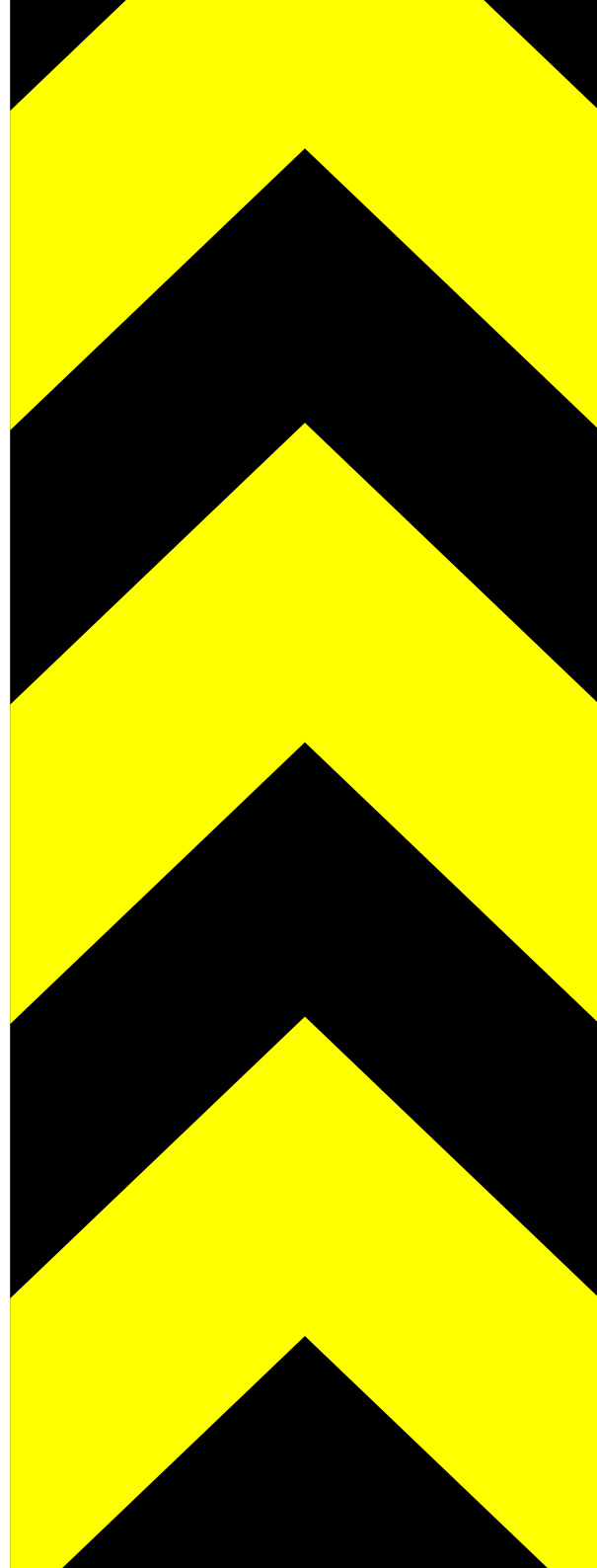

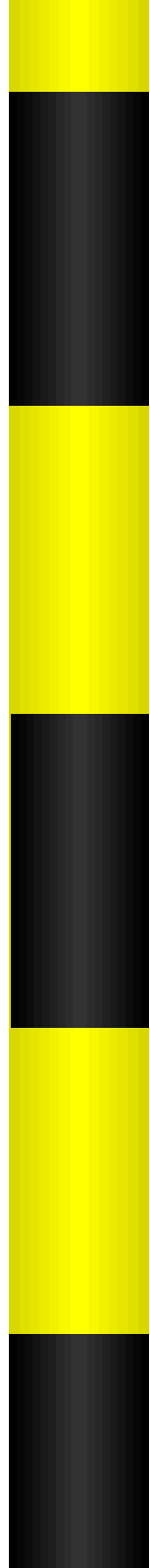

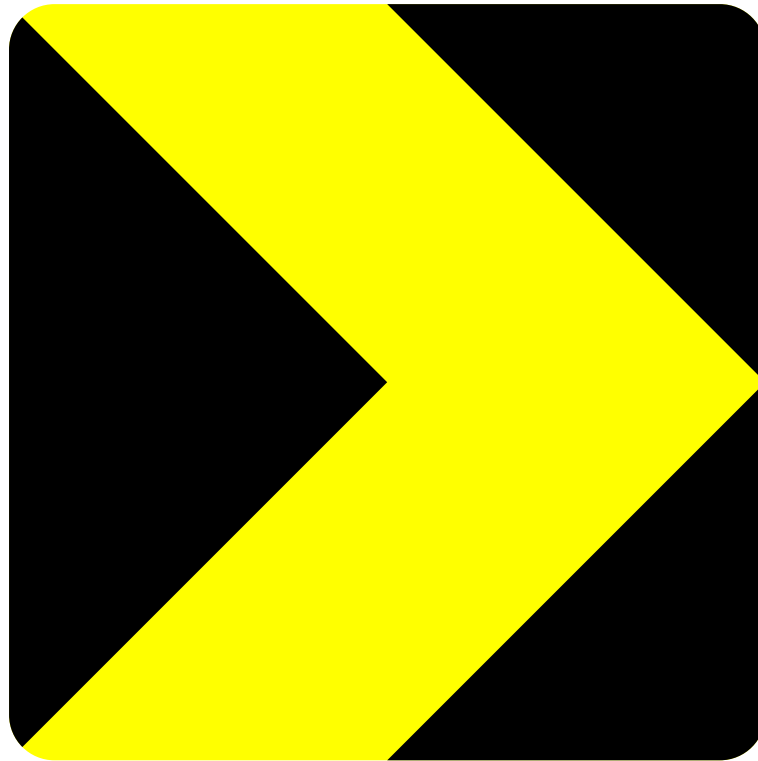

K20.11 Stefnuör

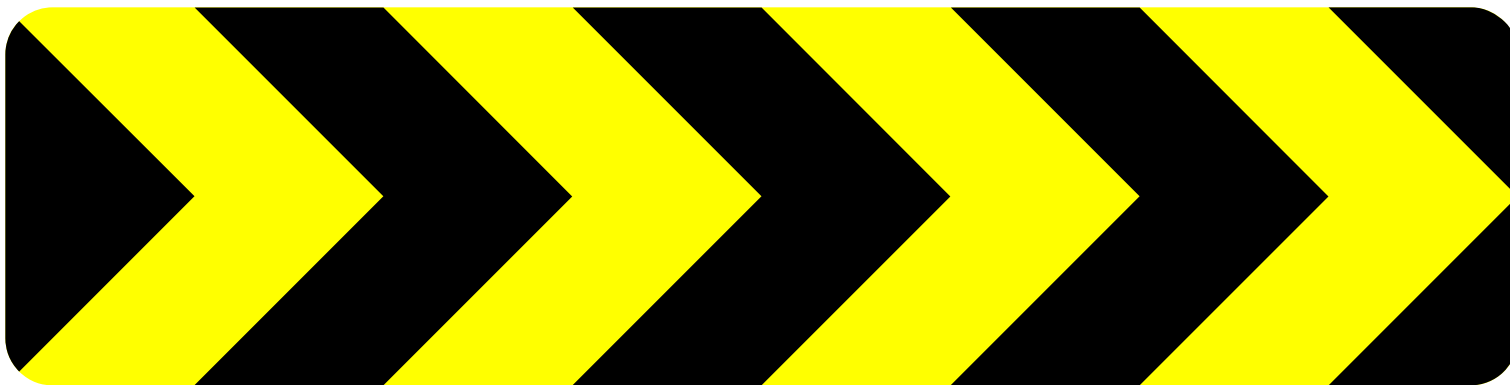

K20.21 Þverslá

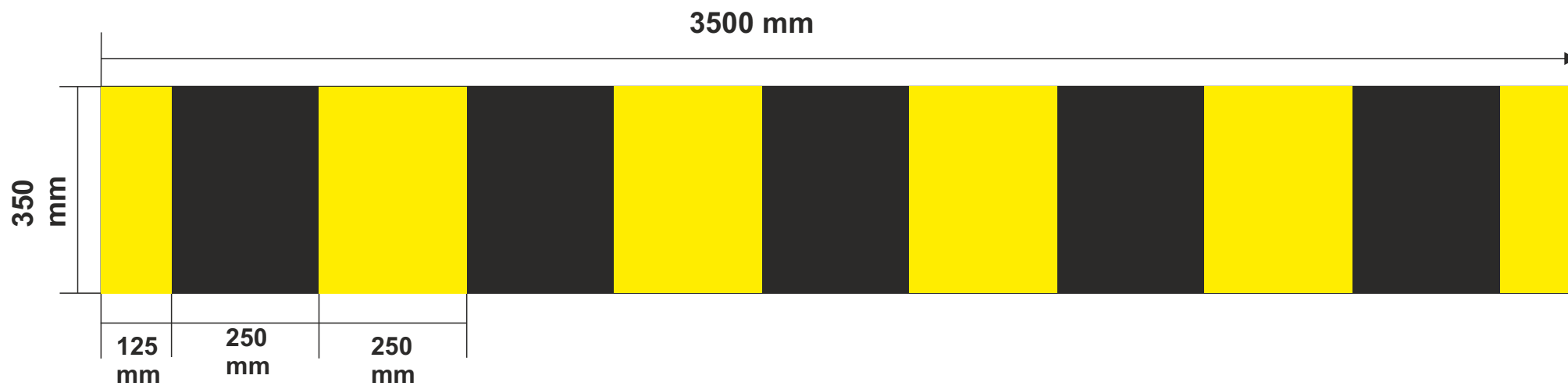

K21.11 Þverslá vegna hæðartakmarkana

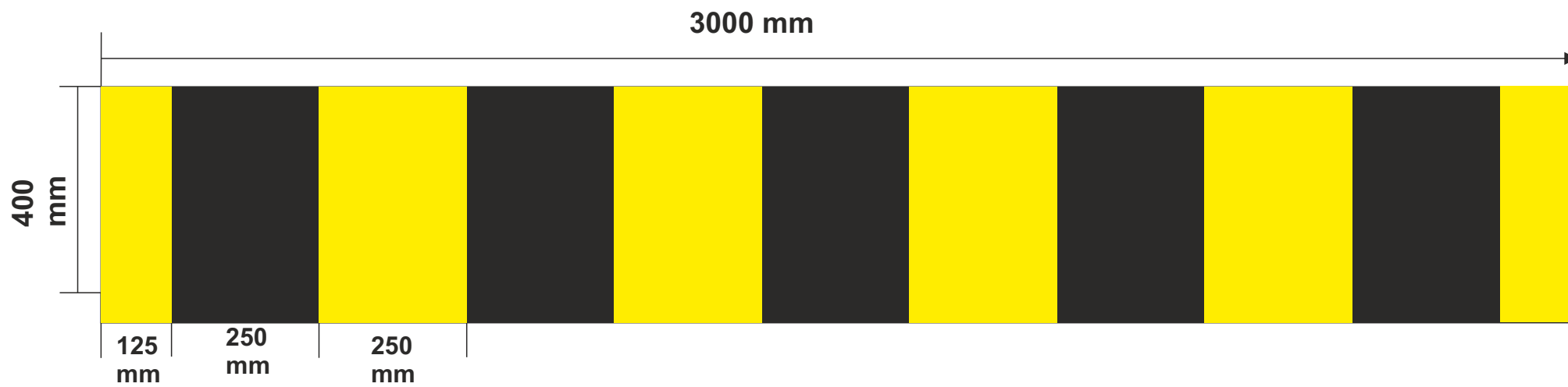

K21.21 Lokunarpverslá

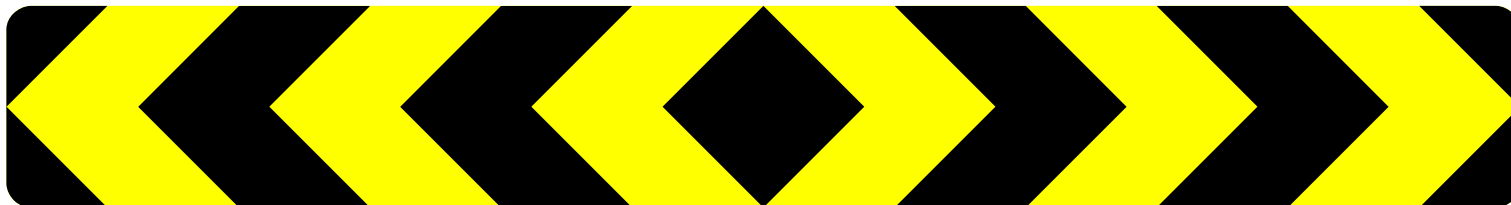

K20.31 Þverslá





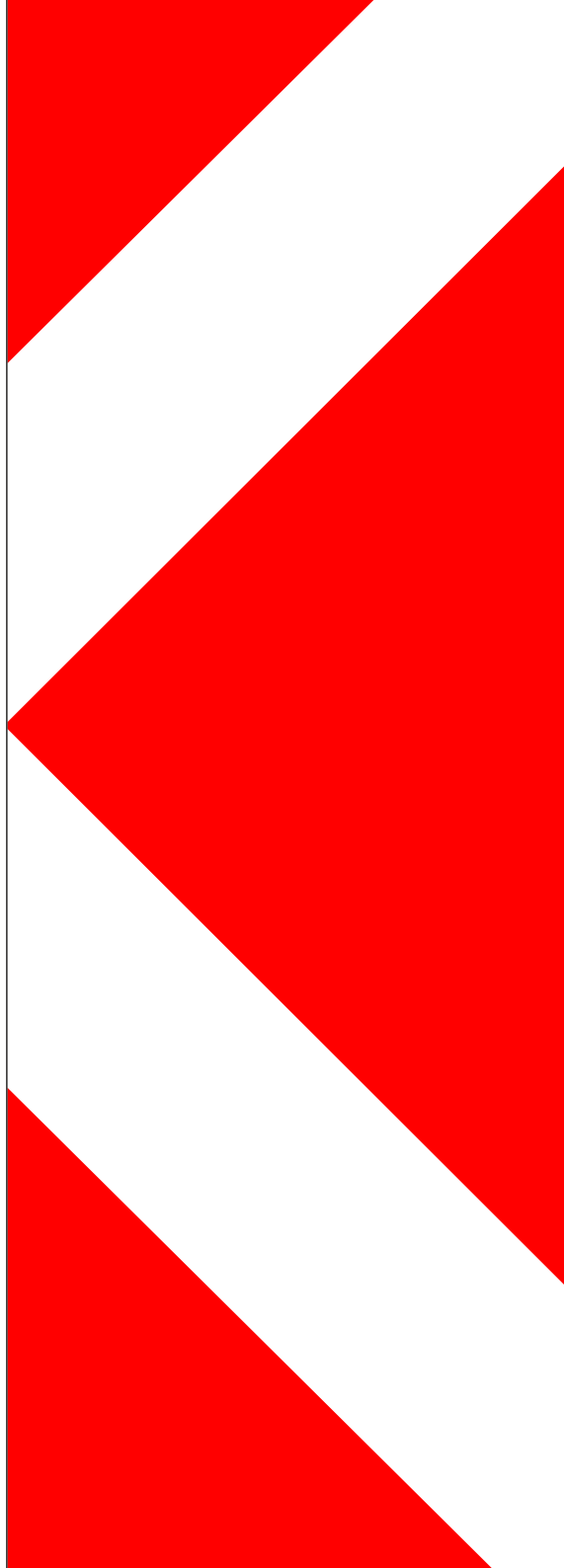

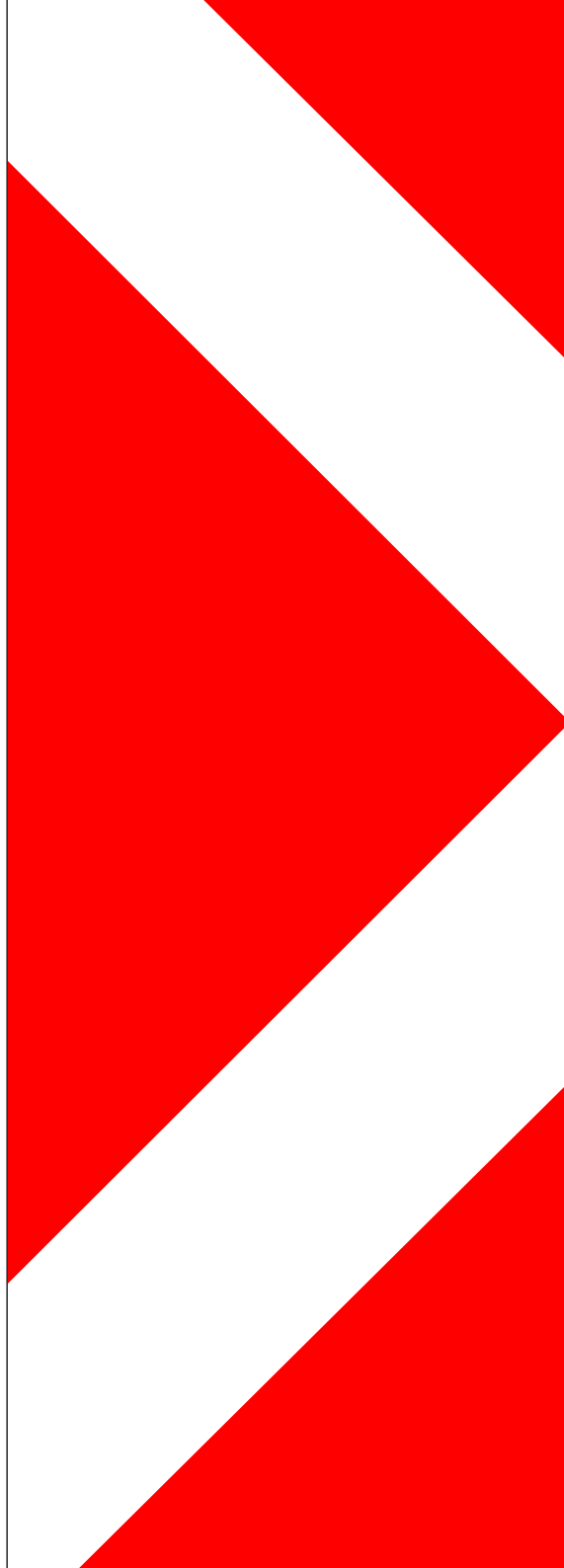

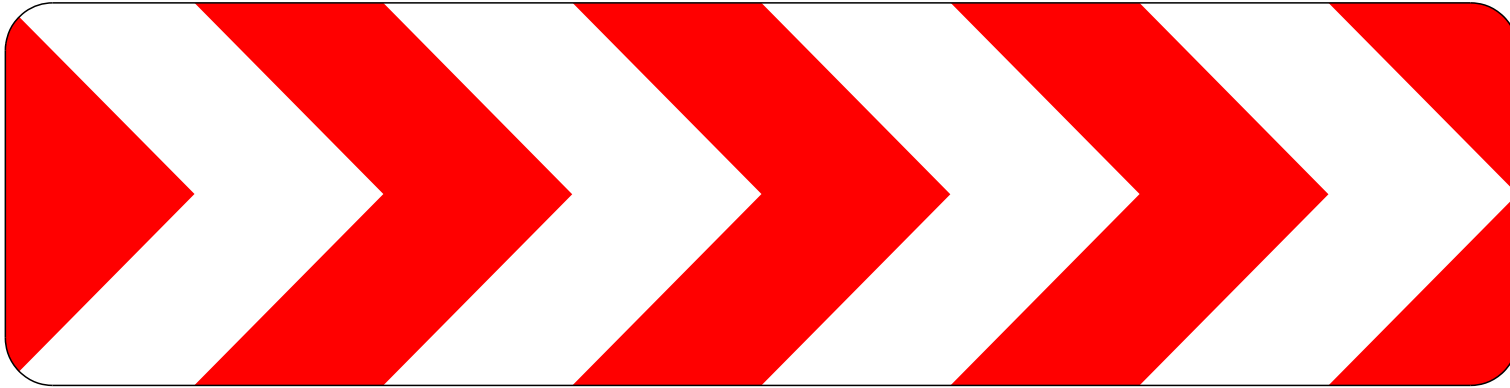

K31.11 Þverslá vegna
framkvæmda

Mælik.1:8

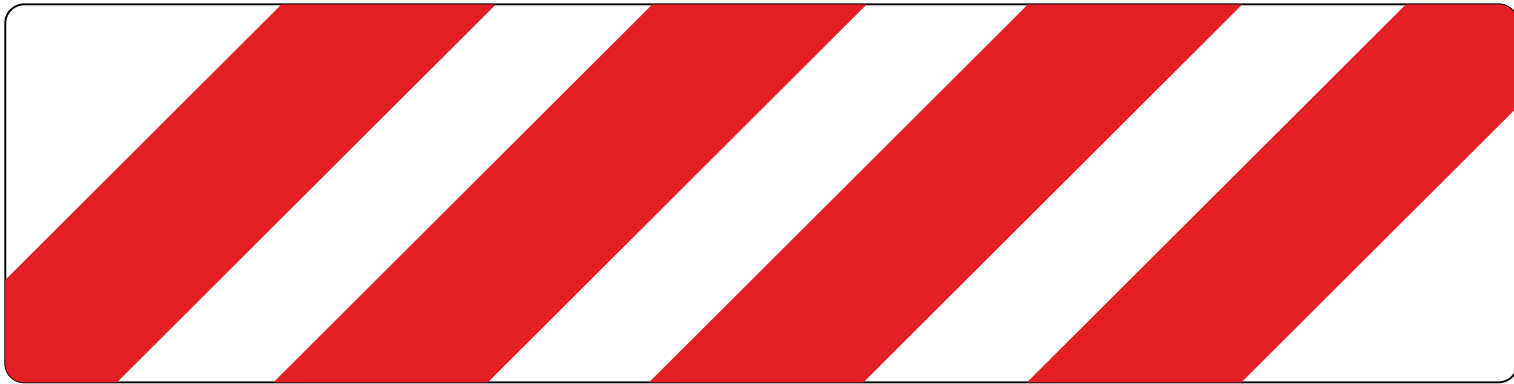

K31.12 Stefnuvísandi gátskjöldur.

Mælik. 1:8



K31.13 Stefnuvísandi gátskjöldur.

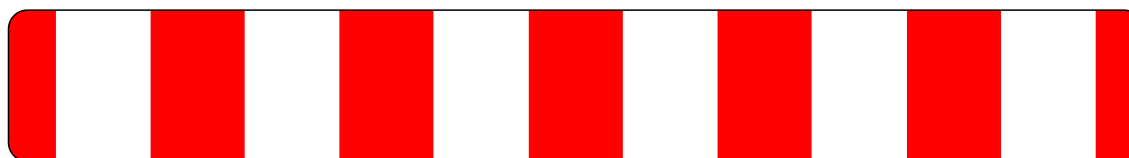

K32.11 Þverslá vegna
framkvæmda

Öll mál í mm

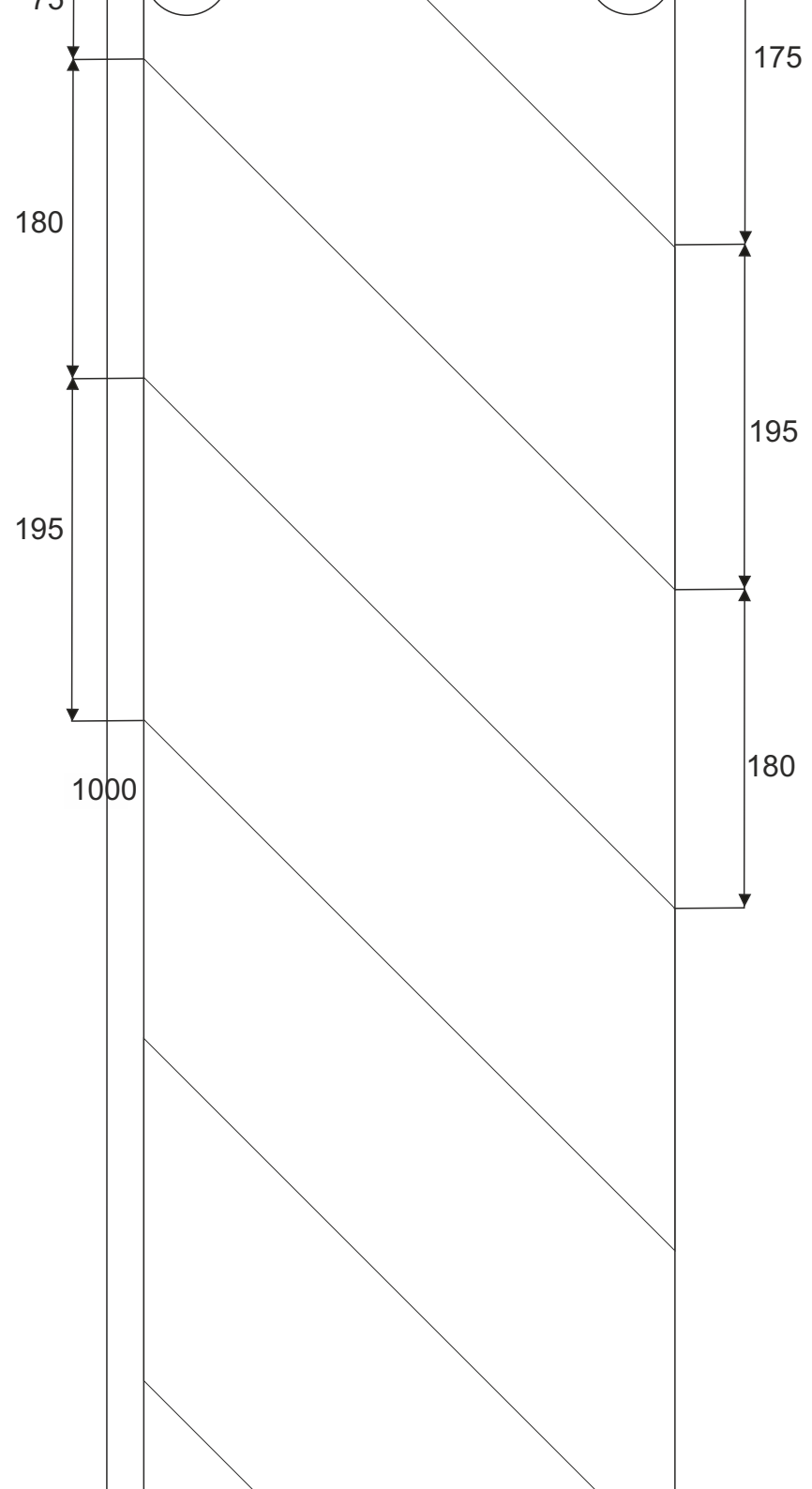

Öll mál í mm

1000

250

250

250

R=24

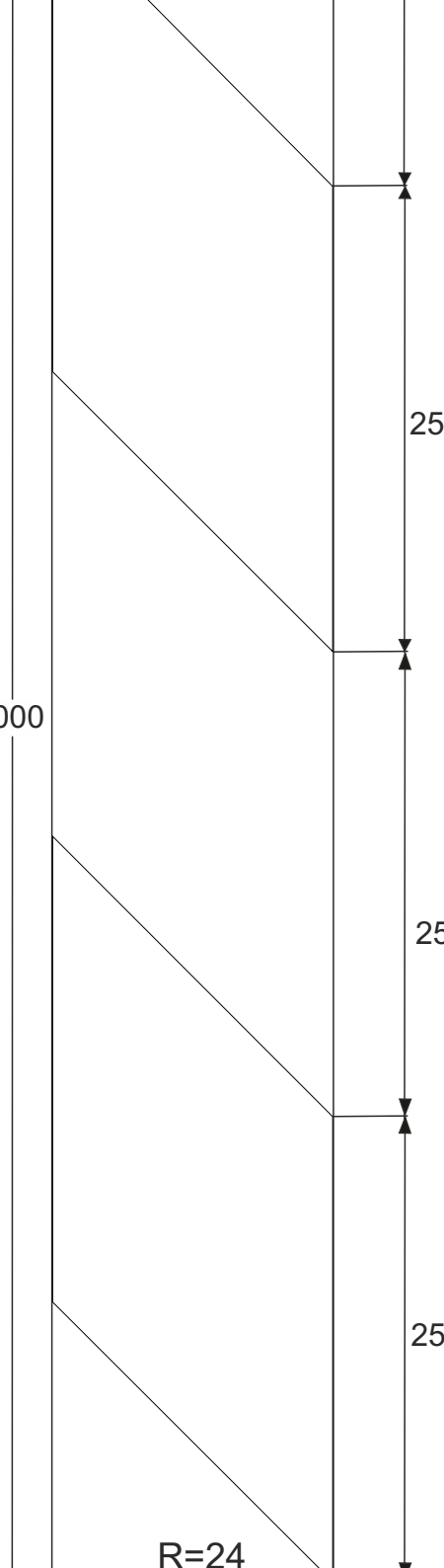

Öll mál í mm

1000

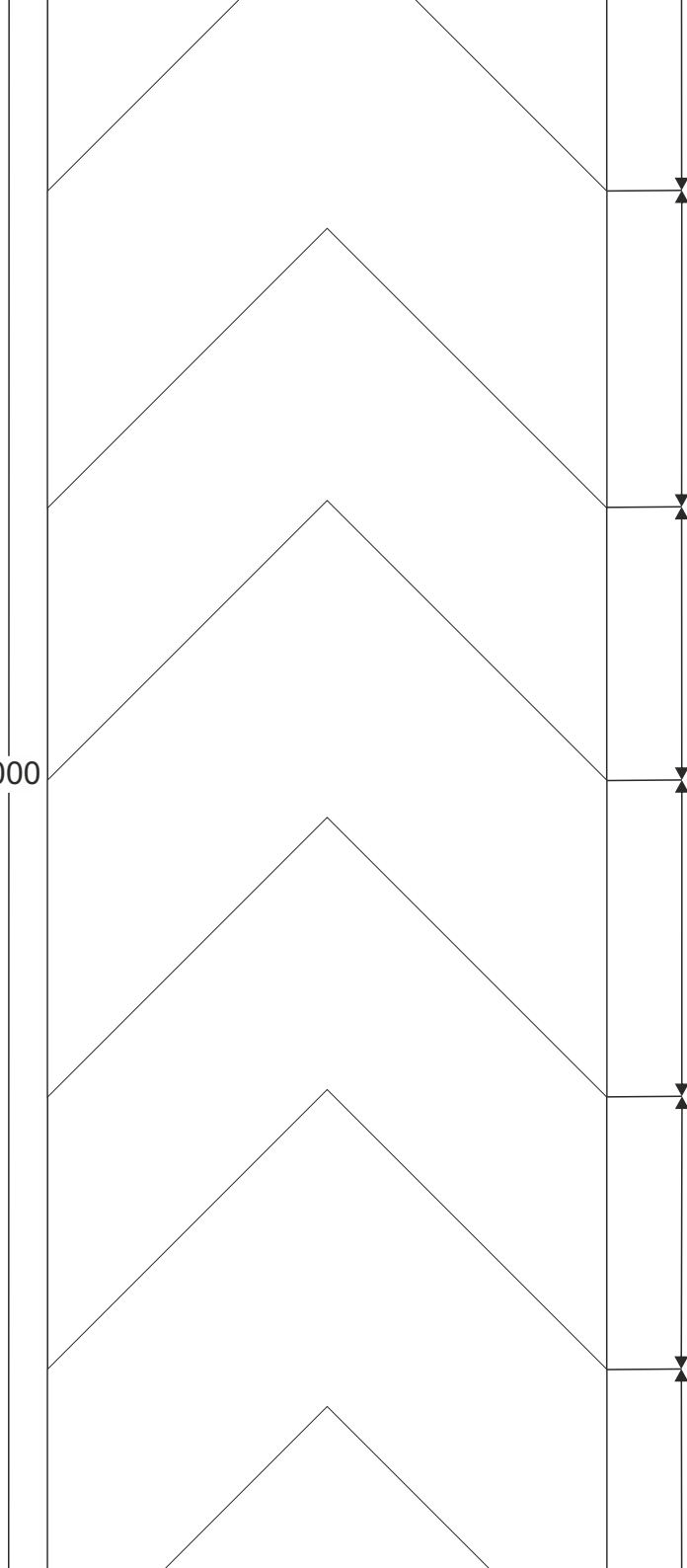

170

170

145

170

145

170



Öll mál í mm

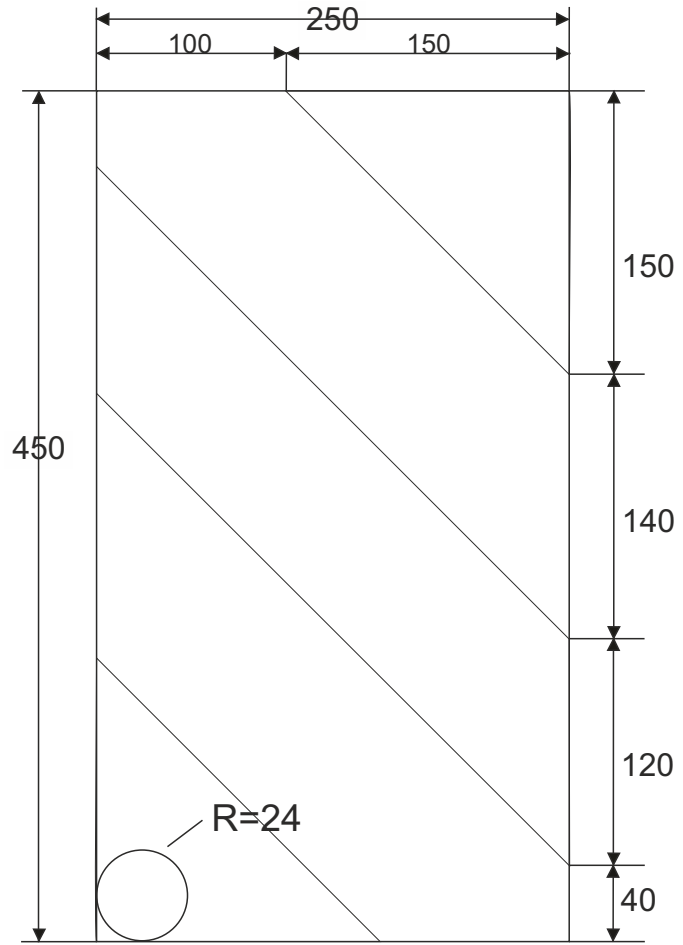

Öll mál í mm

1 m
frá jörðu

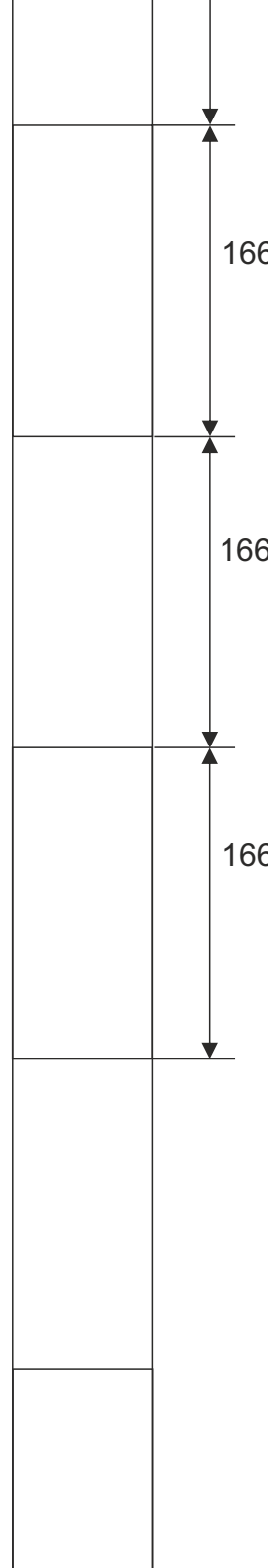

Oll mál í mm
Þetta merki er teiknað 1:8

Stærri gerð
Minni gerð

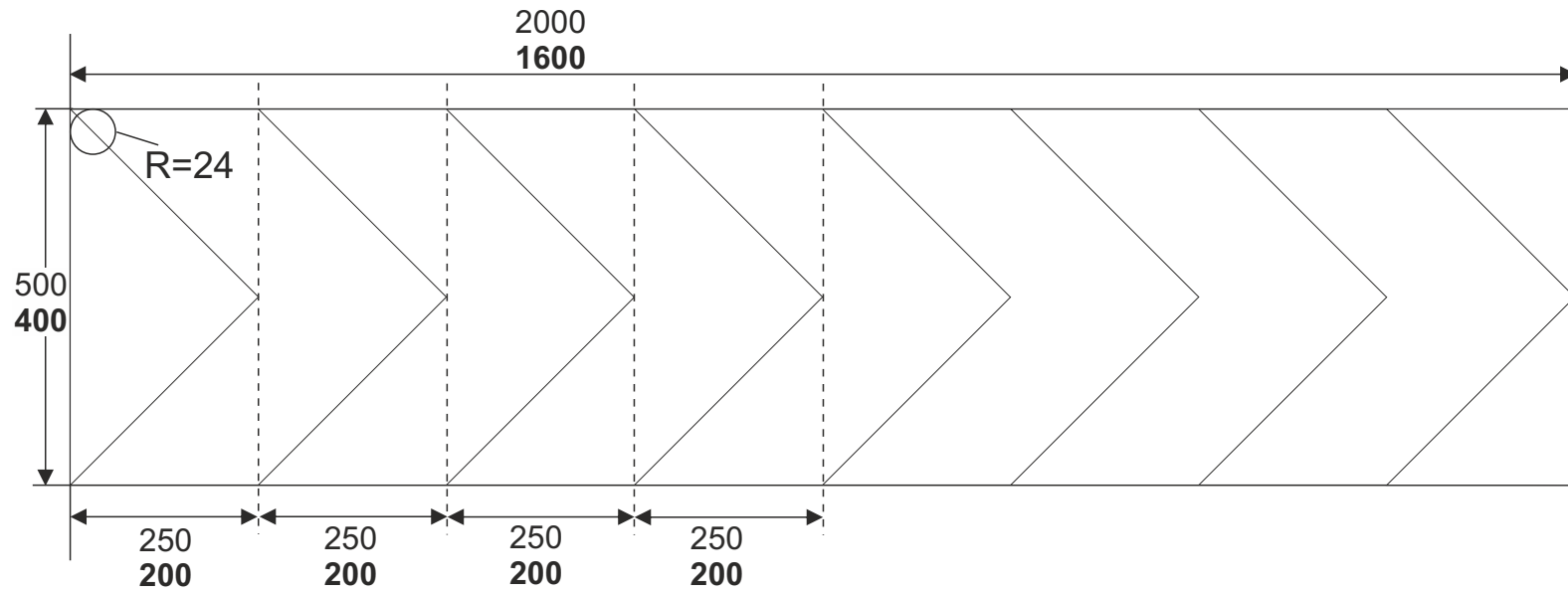

Stærri gerð
Minni gerð

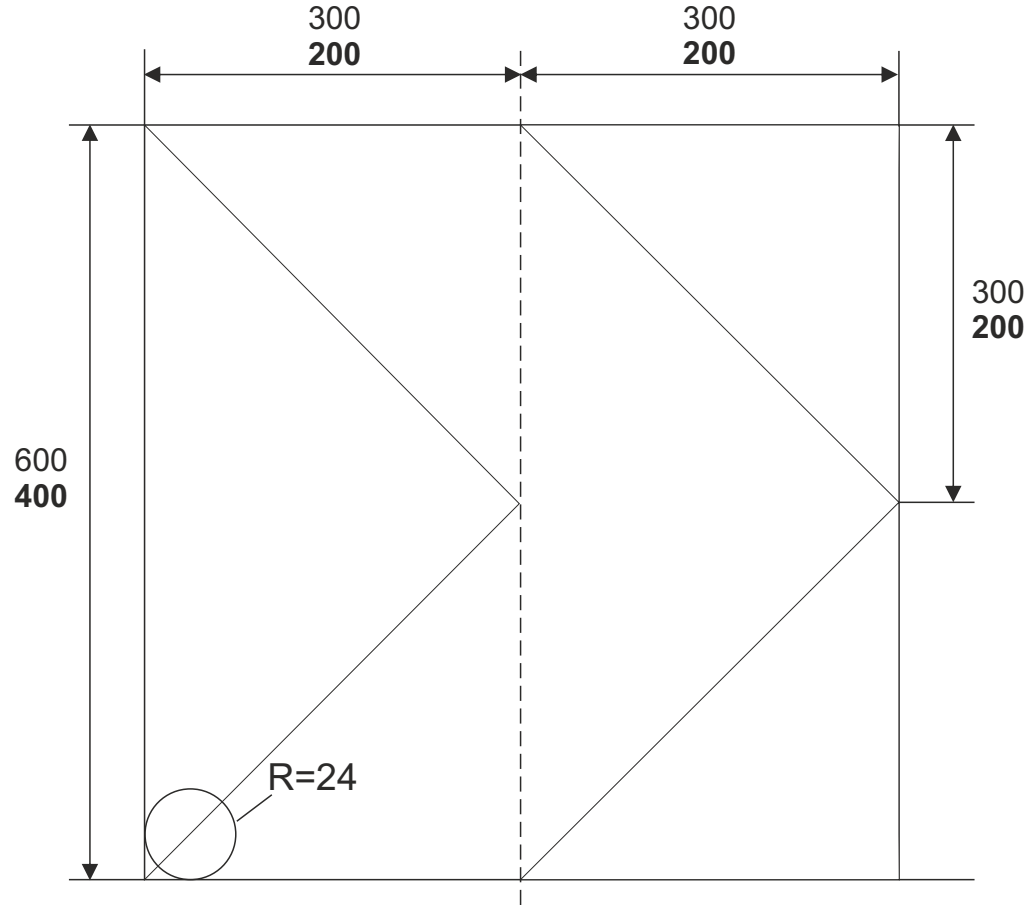

Oll mál í mm
Þetta merki er teiknað 1:15

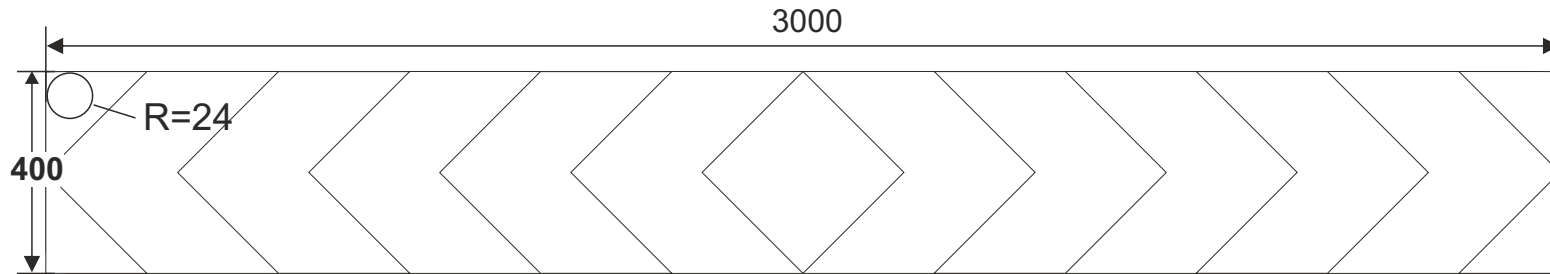

Stærri mynd frá miðju
Þetta merki er teiknað 1:8

